

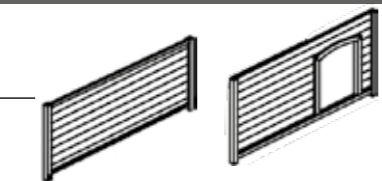

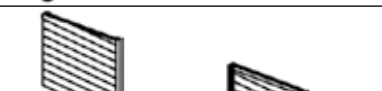

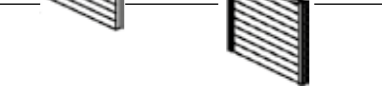

Pos.	Beschreibung Description	Maße Measurement	Anzahl Quantity	Art.-Nr. Item
1	Vorderteil Front part	 785 x 555 x 43 mm	1	39551-30
2	Rückwand Back wall	 785 x 485 x 43 mm	1	39551-31
3	Seitenteil, links Left side panel	 465 x 455 x 32 mm	1	39551-20
4	Seitenteil, rechts Right side panel	 465 x 455 x 32 mm	1	39551-21
5	Seitliche Bodenplatten, groß Side floor plates, large	 472 x 267 x 21 mm	2	39551-10
6	Mittlere Bodenplatte, klein Center floor plate, small	 478 x 198 x 21 mm	1	39551-11
7	Dach inkl. Scharniere Roof incl. hinges	 855 x 590 x 60 mm	1	39551-40

Pos.	Beschreibung Description	Größe Size	Anzahl Quantity	Art.-Nr. Item
A	Gewindeschraube mit Mutter Thread screw with nut	 M6 x 55 mm	8+1	3955-60
B	Senkkopfschraube Countersunk screw	 ø 3,5 x 30 mm	3+1	
C	Linsenkopfschraube Lenshead screw	 ø 3 x 18 mm	16+1	
D	Fangband, links/rechts Check strap, left/right	 plus je 8 Schrauben C plus 8 screws C for each	1/1	3955-70 3955-80
E	Senkkopfschraube Countersunk screw	 ø 3,5 x 50 mm	2+1	3955-60

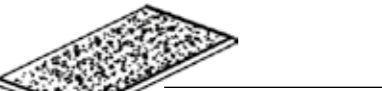
Weitere bereits vormontierte Teile (als Ersatzteile separat erhältlich)  
Other parts already assembled (spare parts separately available)

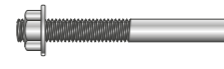
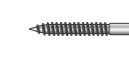
Beschreibung Description	Größe Size	Anzahl Quantity	Art.-Nr. Item
Scharnier für Dach Hinge for roof	7,6 cm	2	6235-74

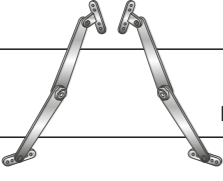
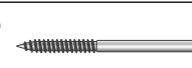
- Ⓧ Sie finden eine französische und italienische Anleitung unter der jeweiligen Artikel-Nummer auf [www.trixie.de](http://www.trixie.de).
- Ⓞ Please find instructions in French and Italian under the corresponding item number at [www.trixie.de](http://www.trixie.de).
- Ⓦ Vous trouverez les informations détaillées en français et en italien à chaque référence d'article, sur notre site [www.trixie.fr](http://www.trixie.fr).
- Ⓛ Le istruzioni in italiano e francese sono disponibili selezionando il codice dell'articolo sul nostro sito [www.trixie.it](http://www.trixie.it).

- Ⓧ Verbinden Sie das Vorderteil (1) und die Rückwand (2) mit den Seitenteilen (3/4).
- Ⓞ Fix the front part (1) and the back wall (2) with the side panels (3/4).

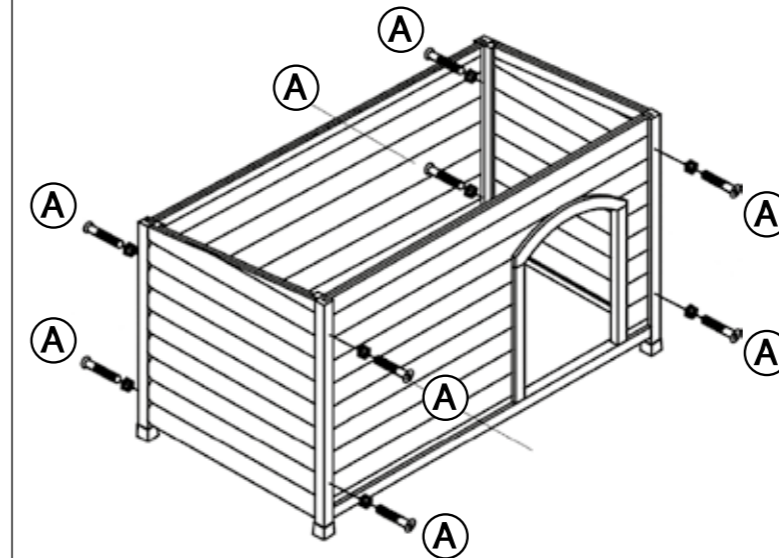

1.

- Ⓧ Legen Sie nun die Bodenplatten (5/6) ein.
- Ⓞ Now insert the floor plates (5/6).

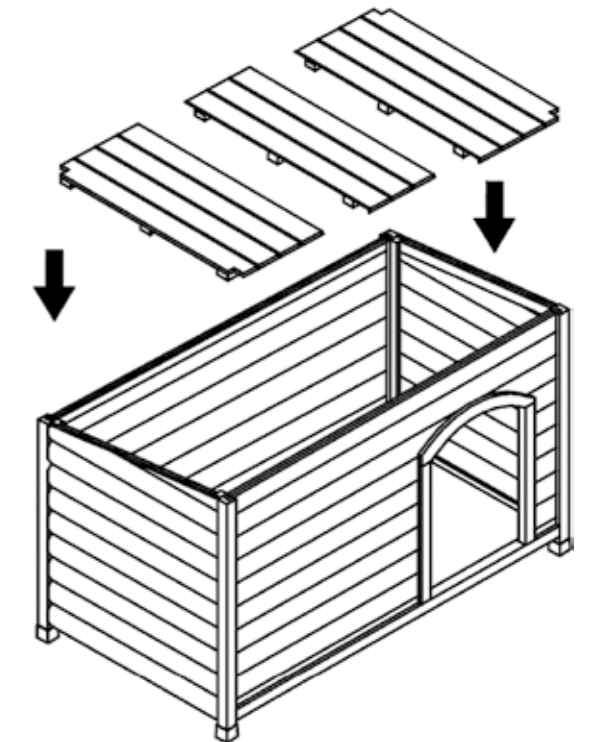

2.

- Ⓧ Befestigen Sie das Dach (7) mit den Schrauben (B). Verschrauben Sie die beiden Fangbänder (D) an den Innenseiten des Daches und der Seitenteile. Fixieren Sie zusätzlich die Hütte an den Seiten (E).
- Ⓞ Install the roof (7) with the enclosed screws (B). Screw the check straps (D) to the inner sides of the roof and the side panels. Additionally fix the sides of the kennel (E).

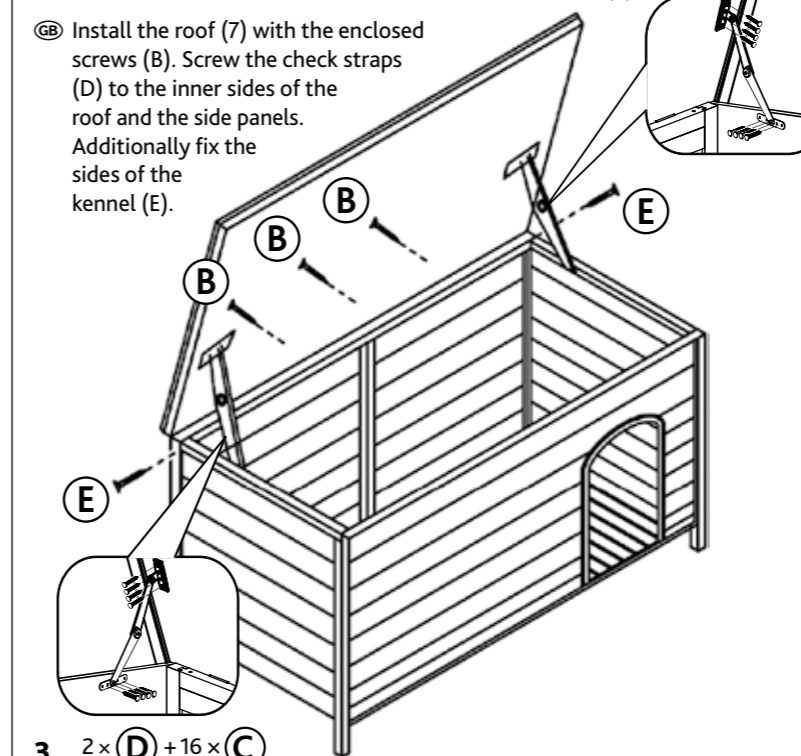

3. 2 x Ⓧ + 16 x Ⓞ

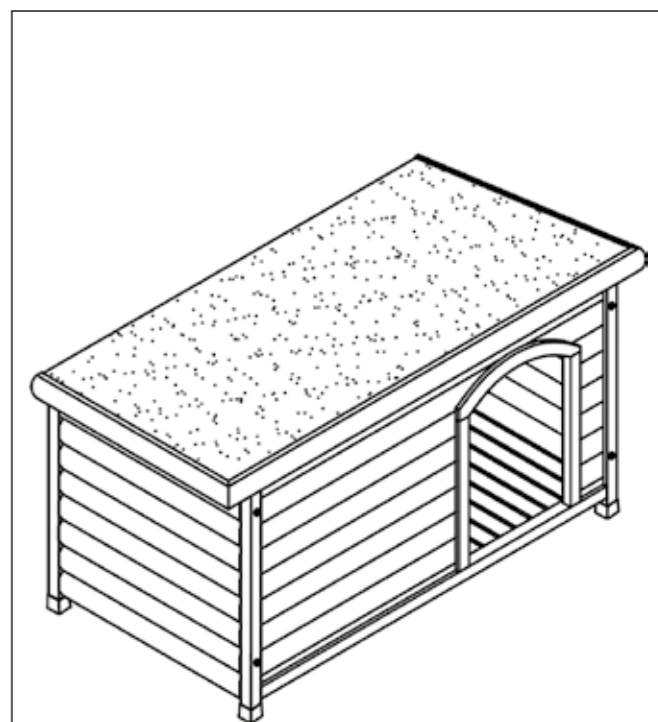

4.